



**TOSHIBA** | **firetv**  
**Quick Setup Guide**

Before using the TV, please read this guide carefully  
and keep it for future reference.

# Copyright statement

© 2021 Hisense Group All Rights Reserved.

Copyright protected material in this Quick Setup Guide may be owned by Hisense group, its contractors or other third parties. Unless otherwise stated, the exercise of any of the exclusive rights under the copyright laws in relation to the material on this site is not permitted without the consent of the rights owner or as otherwise covered by a statutory license.

No part of this publication may be stored, reproduced, transmitted or distributed, in whole or in part, in any manner, electronic or otherwise, whether or not for a charge or for other or no consideration, without the prior written permission of Hisense group. Requests for permission to store, reproduce, transmit or distribute materials may be made to the following address:

## **USA:**

Hisense USA Corporation  
7310 McGinnis Ferry Road  
Suwanee, GA 30024

Hisense USA hereby declares that we are the licensed entities of using, promoting, advertising "TOSHIBA" trademark in relation to licensed products via permitted method. In no event shall anyone be allowed to use, transfer, reproduce, distribute, or transmit in any manner any materials under "TOSHIBA" without written consent by us.

# Disclaimer

Disclaimer: Subscriptions or other payments may be required to access content through some applications. Some or all of the included or downloaded application services in this Toshiba device may not function depending on the Internet connection, local limitations of included applications or other reasons outside of Hisense group's control. Hisense group EXPRESSLY DISCLAIMS RESPONSIBILITY FOR ANY APPLICATION SERVICE FROM FUNCTIONING AT ANY TIME, FOR CONTENT IN ANY APPLICATION SERVICE, FOR DISRUPTIONS OF SERVICE, LOCAL OR REGIONAL LIMITATIONS, WARRANTIES OF TITLE, NO INFRINGEMENT, AND FOR IMPLIED WARRANTIES OF MERCHANTABILITY OR FITNESS FOR A PARTICULAR PURPOSE. By purchasing this device, you accept such Disclaimer without any claim on Hisense group at any time.

## ***This Quick Setup Guide supports the following models:***



**32V35KU**

**43V35KU**

# **Table of Contents**

|  |    |
|--|----|
| What's in the box .....                    | 3  |
| Getting started .....                      | 4  |
| Step 1. Attach stand or mount.....         | 4  |
| Step 2. Connect devices to your TV .....   | 6  |
| Step 3. Get your remote ready.....         | 9  |
| Step 4. Power on the TV .....              | 11 |
| Step 5. Complete the first-time setup..... | 11 |
| Step 6. Enjoy your TV! .....               | 11 |
| Troubleshooting .....                      | 12 |
| Product Specifications .....               | 13 |
| Certification and Compliance.....          | 14 |
| AMAZON TERMS & POLICIES.....               | 16 |

Congratulations on the purchase of your Toshiba TV! If you would like to know 'all things Toshiba', contact us using the support info:  
 The model and serial number of the TV is located on the back and/or on one side of the TV. We recommend that you record this if you ever need service.

| Country | Customer Care Center   | Support Page  | Register your TV   |
|---------|--|---|--|
| U.S.A   | <ul style="list-style-type: none"> <li>• <b>Phone:</b> 1-888-407-0396</li> <li>• <b>Hours of Operation:</b><br/>                     Monday - Friday: 9 AM to 9 PM EST<br/>                     Saturday - Sunday: 9 AM to 6 PM EST</li> <li>• <b>Service Email:</b><br/>                     USAservice@toshiba-visual.com</li> </ul> | <p><a href="https://www.toshibatv-usa.com/support">https://www.toshibatv-usa.com/support</a></p>  <p>For software issues, contact Amazon Fire TV Customer Service:<br/> <a href="http://www.amazon.com/deviceservices/support">www.amazon.com/deviceservices/support</a></p> | <p><a href="https://www.toshibatv-usa.com/support/register/">https://www.toshibatv-usa.com/support/register/</a></p>  |

**Disclaimer:** This Quick Setup Guide is intended as a general guideline to help you set up your TV. Images throughout this document are for illustrative purposes only and may differ from the actual product.

# What's in the box

Your Toshiba TV comes with the following items:

- TV
- 1 set of AAA batteries
- Important Safety Information and Warranty Card
- 2 base stands
- Quick Setup Guide (this document)
- remote control
- 4 screws (M4×25)

## IMPORTANT:

To prevent accidentally discarding items that came with your TV, be sure to **check ALL of the foam** in the carton box.

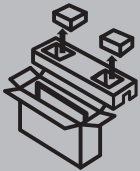

- Please check foam for accessories before discarding.
- Veuillez vérifier la mousse pour qu'il n'y ait pas d'accessoires avant de la jeter.
- Antes de desechar la espuma, asegúrese de retirar todos los accesorios.

You will also need the following items (which are not included) to set up your TV:

- Wireless router (not included) for Internet connectivity
- Phillips screwdriver (not included) to secure the TV stand
- HDMI and other types of cables (not included) to connect external devices to the TV
- Wall mount bracket and screws (not included) if you prefer to mount the TV on the wall

# Getting started

## Step 1. Attach stand or mount

Before you start using your TV, attach your TV stand or mount it on the wall.

### CAUTION:

- Disconnect the AC power cord before installing a stand or a wall mount bracket.
- The display on your TV is fragile. Make sure the TV screen is not scratched or damaged by hard objects or from pressure.
- After the installation is complete, make sure the TV is steady on a table or firmly attached to a wall mount, before removing all protective film, if any.

## Attach the TV stand

To attach the TV stand legs to your TV:

1. Carefully place your TV face down on a clean, soft, flat surface.
2. Insert the TV Base Stand into the bottom slots on your TV.
3. Use the screws provided to secure each stand tightly.

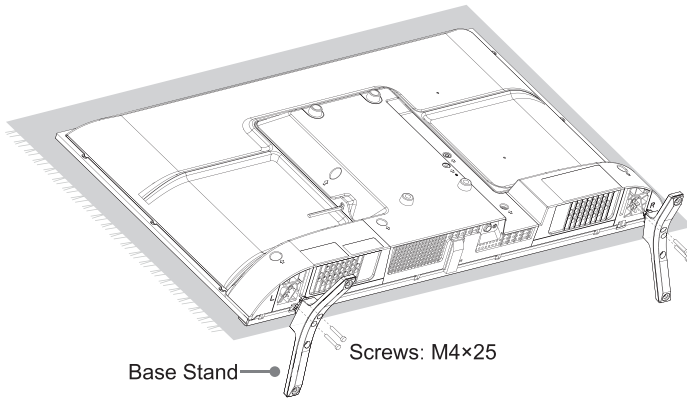

## Attach the wall mount bracket (not included)

Before you begin the third-party manufacturer instructions, be sure to do the following things:

1. Place the TV face down on a clean, safe and cushioned surface.
2. Remove the TV stand if you have already attached it.
3. Place spacers (not included) in the corresponding bracket holes.

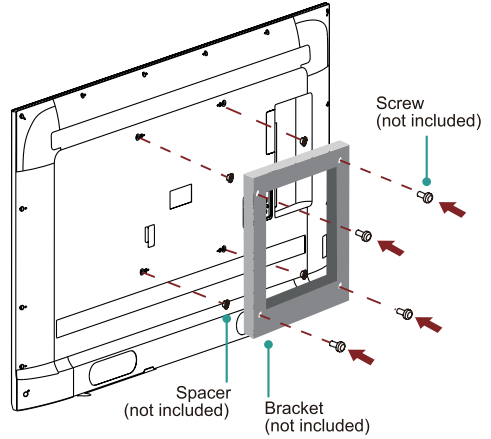

### CAUTION:

- Follow instructions provided with the wall mount bracket. If it is not correctly mounted, the TV may fall and cause property damage or personal injury.
- When you attach the mount, be sure to use spacers (provided by the third-party manufacturer) between the TV and the bracket.
- To prevent internal damage to the TV and to ensure it is mounted securely, be sure to use fixing screws (not included) that are 9.5-11.5 mm in length when measured from the attaching surface of the rear cover.
- Make sure the tilt angle between the TV screen and the vertical surface is no more than 15 degrees.

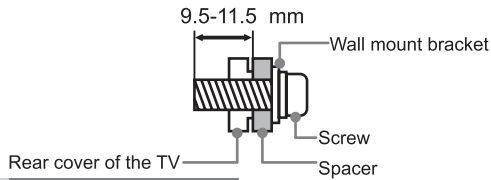
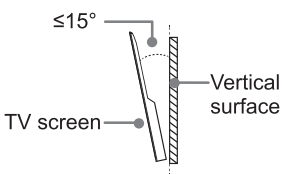

|                             |                                    |
|-----------------------------|------------------------------------|
| Wall mount hole pattern(mm) | 100 × 200 (32")<br>200 × 200 (43") |
| Wall mount screw size       | M6                                 |

### NOTE:

- If you have additional questions, please contact the wall mount manufacturer or the retailer from which you purchased the TV.
- The diameter and length of the screws differ depending on the wall mount bracket model.

## Step 2. Connect devices to your TV

Check to ensure that you have connected right cables for right ports securely. Loose connections can affect the quality of the picture image and color.

Back View

Side View



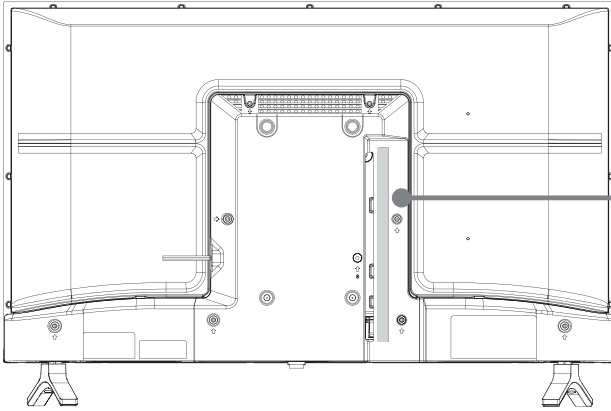



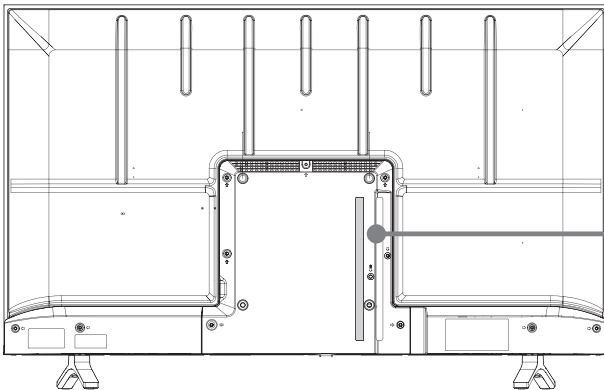



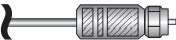



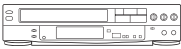





32"





43"

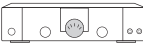
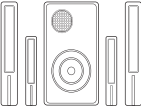



| TV label          | Port  | Cable   | External Equipment  | Brief Description  |
|-------------------|---|---|---|--|
| ANT/CABLE         |    |            | <br>Antenna   | Connect an outdoor VHF/ UHF antenna.   |
| HDMI              |    |            | <br>VCR <br>DVD Player/Recorder <br>Set-top Box <br>Satellite Receiver <br>Video Camera <br>Satellite antenna cable | Connect a High Definition Multimedia Interface (HDMI) cable from an external device.         |
| VIDEO INPUT       | VIDEO   | <br>Yellow | <br>Set-top Box <br>Satellite Receiver <br>Video Camera <br>Satellite antenna cable   | Connect a composite video cable and left-right audio cables from an external AV device.      |
|                   | L   | <br>White  |   |  |
|                   | R   | <br>Red    |   |  |
| DIGITAL AUDIO OUT |  |          | <br>Audio Amplifier <br>Speaker  | Connect an optical cable from an external digital audio system.                              |
| HEADPHONE         |  |          |   | Connect headphones to hear audio from the TV. Headphones with microphones are not supported. |

| TV label | Port  | Cable   | External Equipment | Brief Description  |
|----------|---|---|--------------------|--|
| USB      |  |  |                    | <p>Connect a USB device for browsing photos, music and movies.</p> <p>Hard disks with a total current consumption or impulse current consumption greater than 500mA are not supported.</p> |

### Step 3. Get your remote ready

The following table shows the buttons on your remote control and describes what they are for.

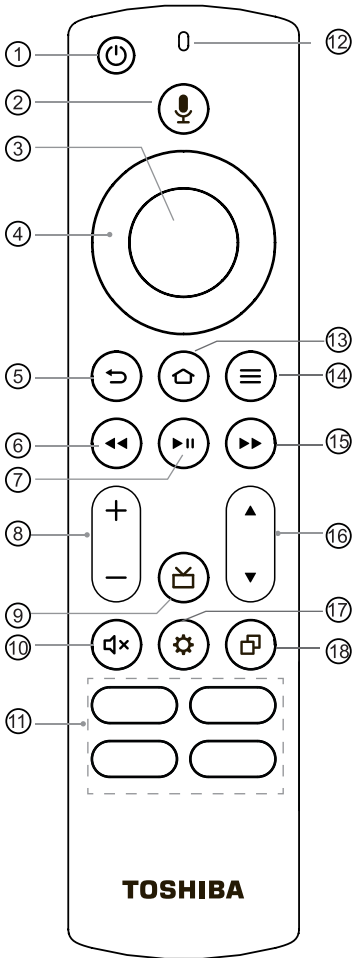

- ① **POWER:** Turn your TV on or off
- ② **Voice button:** Hold down the Voice Button to activate the microphone
- ③ **Select:** Confirm a selection or action
- ④ **D-pad** (up/down/left/right navigation buttons)
- ⑤ **Back:** Return to the previous place in the menu or app
- ⑥ **REWIND:** Rewind streaming video
- ⑦ **PLAY/PAUSE:** Pause or resume playback. This button is also used to activate and use the Live TV Pause feature
- ⑧ **VOLUME + / VOLUME -:** Increase / decrease the volume
- ⑨ **Guide:** Open the Live TV Channel Guide
- ⑩ **MUTE:** Mute or un-mute the sound
- ⑪ **App buttons:** Quick access buttons to apps
- ⑫ **Microphone:** Receive voice commands
- ⑬ **HOME:** Display your TV's Home screen
- ⑭ **MENU:** The button for the Menu
- ⑮ **FAST FORWARD:** Fast forward streaming video
- ⑯ **Channel** (up/down): Navigate to the next or previous Live TV channel
- ⑰ **Quick Settings:** Activate quick settings overlay
- ⑱ **Recents:** Open a row of recently watched content so you can easily switch between content.

#### NOTE:

- The picture is only for reference. Check information according to the actual remote control.

## **Insert the batteries**

Remove the battery door and insert the two AAA batteries into your Alexa Voice Remote.

## **Important information about the remote and batteries**

- **Discard batteries in a designated disposal area. Do not throw them into a fire.**
- **Remove old batteries immediately to prevent them from leaking into the battery compartment.**
- **If you do not intend to use the remote control for a long time, then remove the batteries.**
- **Battery chemicals can cause a rash. If the batteries leak, clean the battery compartment with a cloth. If chemicals touch your skin then wash it immediately.**
- **Only use new 1.5v alkaline or 1.2NiMH rechargeable AAA sized batteries.**
- **Do not mix alkaline or rechargeable NiMH batteries.**
- **Do not continue using the remote if it gets warm or hot.**
- **Call our Support Center immediately on the support website.**

## **Using your cable set-top box or satellite receiver remote as a ‘universal’ remote**

If you prefer to use your Cable Set-top Box or Satellite Receiver Remote as a ‘universal’ remote, then visit the Support page to view a list of the codes.

## Step 4. Power on the TV

Connect the power cord to the power outlet.

Your TV will display a launch screen showing the Toshiba logo.

## Step 5. Complete the first-time setup

The first time you turn on your TV, there is a guided setup to make it easy to connect your TV to the Internet and complete the setup of your TV.

Your TV will automatically pair with your new Alexa Voice Remote.

1. If there are issues with the remote pairing, you will be prompted to pair your remote by pressing the **Home** button. If you continue to have issues, try re-inserting or replacing your batteries.
2. Select your Wi-Fi network from the list of Wi-Fi networks displayed on the screen.

### NOTE:

- If your Wi-Fi network is password protected, please have your Wi-Fi network password handy to connect your TV to the Internet. If your network is hidden, select the **Join Other Network**. If required, enter your network password using the on-screen keyboard.

## Step 6. Enjoy your TV!

Now that you've completed the first-time setup, your Home screen is your starting point for using your TV. Your Toshiba TV provides a variety of entertainment options, so you'll always find something new. Use your TV to watch live channels, access video on demand to watch movies, and much more.

# Troubleshooting

If you are having trouble with your TV, first try turning it off and on again. If this does not fix the problem, check the tips in the following table. If your problem is not listed in the following table, then contact us at one of the phone numbers on Page 2.

| Issues   | Possible solutions  |
|--|---|
| No sound or picture  | <ul style="list-style-type: none"> <li>• Check if the power cord is plugged into a powered AC outlet.</li> <li>• Press the Power button on the remote control to activate the unit from 'Standby' mode.</li> <li>• Check to see if the LED light is on or not. If it is, then the TV is receiving power.</li> </ul> |
| I have connected an external source to my TV and I get no picture and/or sound.                      | <ul style="list-style-type: none"> <li>• Check for the correct output connection on the external source and for the correct input connection on the TV.</li> <li>• Make sure you have made the correct selection for the input mode for the incoming signal.</li> </ul>   |
| When I turn on my TV, there is a delay for a few seconds before the picture appears. Is this normal? | <ul style="list-style-type: none"> <li>• Yes, this is normal. The TV is initializing and searching for previous setting information.</li> </ul>   |
| The picture is normal but there is no sound  | <ul style="list-style-type: none"> <li>• Check the volume settings.</li> <li>• Check if 'Mute' mode is set to On.</li> </ul>  |
| Sound but no picture or black and white picture  | <ul style="list-style-type: none"> <li>• If the picture is black and white, unplug the TV from the AC outlet and replug it after 60 seconds.</li> <li>• Check that the Color is set to 50 or higher.</li> <li>• Try different TV channels.</li> </ul>   |
| The sound and/or picture is distorted or appears wavy  | <ul style="list-style-type: none"> <li>• An electric appliance may be affecting the TV. Turn off any appliances that are nearby and move it farther away from the TV.</li> <li>• Insert the power plug of the TV set into another power outlet.</li> </ul>  |
| The sound and picture is blurry or cuts out  | <ul style="list-style-type: none"> <li>• If using an external antenna, check the direction, position and connection of the antenna.</li> <li>• Adjust the direction of your antenna or reset or fine tune the channel.</li> </ul>   |
| A horizontal or vertical stripe appears on the picture and/or the picture is shaking                 | <ul style="list-style-type: none"> <li>• Check if there is an appliance or electric tool nearby that is causing interference.</li> </ul>  |
| The plastic cabinet makes a "clicking" type of sound   | <ul style="list-style-type: none"> <li>• The 'click' sound can occur when the temperature of the television changes. This change causes the television cabinet to expand or contract, which makes the sound. This is normal and the TV is OK.</li> </ul>  |
| The remote control does not work   | <ul style="list-style-type: none"> <li>• Confirm that TV still has power and is operational.</li> <li>• Change the batteries in the remote control.</li> <li>• Check if the batteries are correctly installed.</li> </ul>   |

# Product Specifications

| Model Name                    |               | 32V35KU   | 43V35KU  |
|-------------------------------|---------------|---|--|
| Dimension<br>(W × H × D)      | Without Stand | 28.2 × 16.9 × 3.4 inches<br>(717 × 428 × 86 mm)   | 37.6 × 22.0 × 3.4 inches<br>(955 × 558 × 87 mm)  |
|                               | With Stand    | 28.2 × 18.6 × 7.3 inches<br>(717 × 473 × 186 mm)  | 37.6 × 23.9 × 7.9 inches<br>(955 × 606 × 200 mm) |
| Weight                        | Without Stand | 8.4 lbs (3.8 kg)  | 14.1 lbs (6.4 kg)                                |
|                               | With Stand    | 8.6 lbs (3.9 kg)  | 14.3 lbs (6.5 kg)                                |
| TV Stand Width(W × D)         |               | 26.0 × 7.3 inches<br>(661 × 186 mm)   | 31.0×7.9 inches<br>(787 × 200 mm)                |
| Class                         |               | 32"   | 43"  |
| Active Screen Size (Diagonal) |               | 31.5 inches (80.0 cm)   | 42.5 inches (107.9 cm)                           |
| Screen Resolution             |               | 1366 × 768  | 1920 × 1080                                      |
| Audio Power                   |               | 6 W + 6 W   | 8 W + 8 W  |
| Power consumption             |               | 50 W  | 75 W   |
| Power Supply                  |               | 120 V ~ 60 Hz   |  |
| Connectivity                  |               | Built-in Wireless feature (1x1 dual band)   |  |
| Ports                         |               | 3 HDMI ports, 2 USB ports, 1 Digital Audio Output, 1 Headphone Audio Output, 1 RCA Composite Video Input , 1 left/right Audio Input for Composite, 1 RF Input |  |
| Receiving Channels            |               | VHF: 2 - 13, UHF: 14 - 69, CATV: 1 - 125<br>Digital Terrestrial Broadcast (8VSB): 2 - 69<br>Digital cable (64/256 QAM): 1 - 135                               |  |
| Tuner Type                    |               | Frequency synthesized   |  |
| Receiving System              |               | Analog: NTSC<br>Digital: ATSC/QAM   |  |
| Operating Temperature         |               | 41°F - 95°F (5°C - 35°C)  |  |
| Operating Humidity            |               | 20% to 80% non-condensing   |  |
| Storage Temperature           |               | 5°F to 113°F (-15°C to 45°C)  |  |
| Storage Humidity              |               | 10% to 70%, non-condensing  |  |

**Disclaimer:** All products, product specifications, and data are subject to change without notice to improve reliability, function, design or otherwise.

# Certification and Compliance

## FCC Notice

This device has been tested and found to comply with the limits for a Class B digital device pursuant to Part 15 of the FCC Rules. These limits are designed to provide reasonable protection against harmful interference in a residential installation. This device generates, uses, and can radiate radio frequency energy and, if not installed and used in accordance with the instructions, may cause harmful interference to radio communications.

However, there is no guarantee that interference will not occur in a particular installation. If this device does cause harmful interference to radio or television reception, which can be determined by turning the device off and on, the user is encouraged to try to correct the interference by one or more of the following measures:

- Reorient or relocate the receiving antenna.
- Increase the separation between the device and receiver.
- Connect the device into an outlet on a circuit different from that to which the receiver is connected.
- Consult the dealer or an experienced radio/TV technician for help.

**NOTE:** The manufacturer is not responsible for any radio or TV interference caused by unauthorized modifications to this equipment. Such modifications could void the user's authority to operate the equipment.

The Wi-Fi Module complies with FCC radiation exposure limits set forth for an uncontrolled environment. This device should be installed and operated with a minimum distance of 20 centimeters between the radiator and your body.

## Declaration of Conformity

Trade Name: Toshiba

Model: 32V35KU / 43V35KU

Responsible Party: Hisense USA Corporation

Address: 7310 McGinnis Ferry Road, Suwanee, GA 30024

Telephone Number: 678-318-9060

This device complies with Part 15 of the FCC Rules. Operation is subject to the following two conditions: (1) this device may not cause harmful interference, and (2) this device must accept any interference received, including interference that may cause undesired operation.





The terms HDMI and HDMI High-Definition Multimedia Interface, and the HDMI Logo are trademarks or registered trademarks of HDMI Licensing Administrator, Inc. in the United States and other countries.



Dolby, Dolby Audio, and the double-D symbol are trademarks of Dolby Laboratories Licensing Corporation. Manufactured under license from Dolby Laboratories. Confidential unpublished works. Copyright 1992–2019 Dolby Laboratories. All rights reserved.



For DTS patents, see <http://patents.dts.com>. Manufactured under license from DTS, Inc. (for companies headquartered in the U.S./Japan/Taiwan) or under license from DTS Licensing Limited (for all other companies). DTS, DTS-HD Master Audio, DTS-HD, Virtual:X, and the DTS-HD logo are registered trademarks or trademarks of DTS, Inc. in the United States and other countries. © 2020 DTS, Inc. ALL RIGHTS RESERVED.

**NOTE:**

- This product does not support decoding of DTS CD bitstreams. Playback of this format may produce undesirable noise.



**Environmental Protection**

This mark indicates that this product should not be disposed together with other domestic garbage, to avoid damage to the environment or human health due to the disposal of uncontrolled waste. Recycle it responsibly for promoting the sustainable reuse of material resources. To return your used device, please use the return systems available in your location or contact the vendor where you purchased your product they could take this product for recycling and protection of the environment.

©2021. All rights reserved.

Amazon, Fire, and all related marks are trademarks of Amazon.com, Inc. or its affiliates.

# AMAZON TERMS & POLICIES

Before using Fire TV Edition, please read the terms located at [www.amazon.com/deviceservices/support](http://www.amazon.com/deviceservices/support). Please also read all terms and policies for services related to Fire TV Edition, including but not limited to Amazon's Privacy Notice located at [www.amazon.com/privacy](http://www.amazon.com/privacy), Amazon's Conditions of Use located at [www.amazon.com/conditionsofuse](http://www.amazon.com/conditionsofuse), and any other terms or usage provisions available at [www.amazon.com/deviceservices/support](http://www.amazon.com/deviceservices/support). All terms, rules, notices, policies, and provisions are, collectively, the "Agreements." By using Fire TV Edition, you agree to be bound by the terms of the Agreements.